

SIAM/NEVA

FRONT PLATE

FACE AVANT

Description

Material : full brass.

Windows opening : 1 round hole + 1 round hole for PB (E).

Button: round button.

Silicone: to reduce sound impact between buttons and face plate.

POSITION

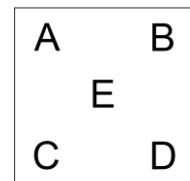

Caractéristiques

Matière : laiton massif.

Fenêtre : 1 ouverture ronde + 1 ouverture ronde pour BP (E).

Bouton: bouton rond.

Silicone : réduit l'impacte du son entre le bouton et la face avant.

Ref.	Finish	Finition	Effect	Effet
PSI131LMH	Polished mirror brass	Laiton miroir	Shiny	Brillant
PSI131LBH	Brushed brass	Laiton brossé	Matt	Mat
PSI131LSH	Microbilled/satin brass	Laiton microbillé	Satin	Satin
PSI131VOH	Antique/old gold	Vieil or	Matt	Mat
PSI131BMH	Medium bronze	Bronze moyen	Matt	Mat
PSI131BRH	Dark bronze	Bronze noir	Shiny	Brillant
PSI131BZH	Grey bronze	Bronze gris	Matt	Mat
PSI131NMH	Polished mirror nickel	Nickel miroir	Shiny	Brillant
PSI131NBH	Brushed nickel	Nickel brossé	Matt	Mat
PSI131NSH	Microbilled/satin nickel	Nickel brossé	Matt	Mat
PSI131CHH	Polished mirror chrome	Chrome miroir	Shiny	Brillant
PSI131ROH	Brushed copper	Cuivre brossé	Matt	Mat
PSI131RAH	RAL code 9003	RAL codes 9003	Matt	Mat
PSI131ORH	24K gold	24K or	Shiny	Brillant
PSI131OMH	24K microbilled gold	microbillé 24K or	Satin	Satin

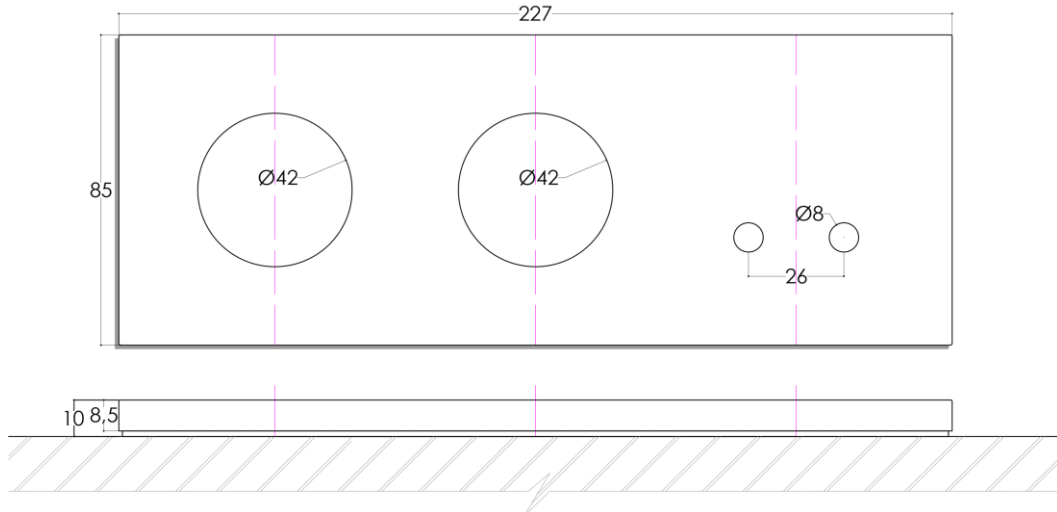

SIAM/NEVA

FRONT PLATE

FACE AVANT

Description

Material : full brass.
 Windows opening : 2 round holes + 2 round holes for PB (CD).
 Button: round buttons.
 Silicone: to reduce sound impact between buttons and face plate.

POSITION

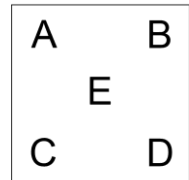

Caractéristiques

Matière : laiton massif.
 Fenêtre : 2 ouvertures ronds + 2 ouvertures rondes pour BP (CD).
 Bouton: boutons ronds.
 Silicone : réduit l'impacte du son entre le bouton et la face avant.

Ref.	Finish	Finition	Effect	Effet
PSI157LMH	Polished mirror brass	Laiton miroir	Shiny	Brillant
PSI157LBH	Brushed brass	Laiton brossé	Matt	Mat
PSI157LSH	Microbilled/satin brass	Laiton microbillé	Satin	Satin
PSI157VOH	Antique/old gold	Vieil or	Matt	Mat
PSI157BMH	Medium bronze	Bronze moyen	Matt	Mat
PSI157BRH	Dark bronze	Bronze noir	Shiny	Brillant
PSI157BZH	Grey bronze	Bronze gris	Matt	Mat
PSI157NMH	Polished mirror nickel	Nickel miroir	Shiny	Brillant
PSI157NBH	Brushed nickel	Nickel brossé	Matt	Mat
PSI157NSH	Microbilled/satin nickel	Nickel brossé	Matt	Mat
PSI157CHH	Polished mirror chrome	Chrome miroir	Shiny	Brillant
PSI157ROH	Brushed copper	Cuivre brossé	Matt	Mat
PSI157RAH	RAL code 9003	RAL codes 9003	Matt	Mat
PSI157ORH	24K gold	24K or	Shiny	Brillant
PSI157OMH	24K microbilled gold	microbillé 24K or	Satin	Satin

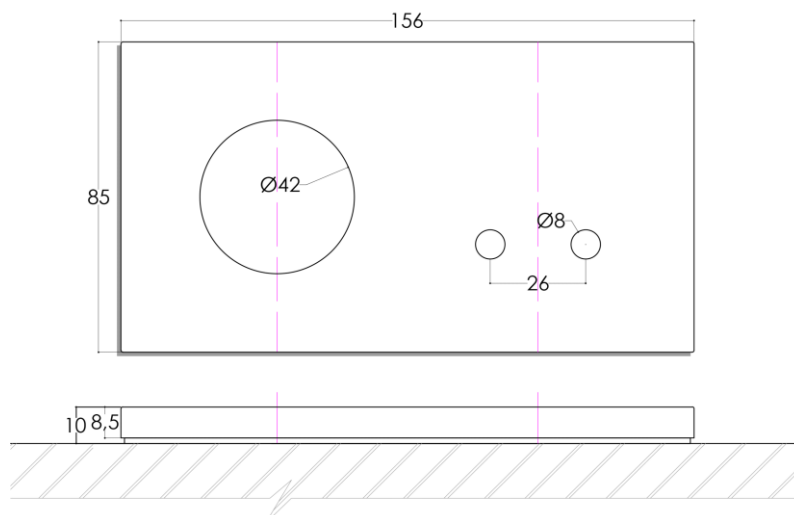

SIAM/NEVA

FRONT PLATE

FACE AVANT

Description

Material : full brass.

Windows opening : 1 round hole + 2 round holes for PB (CD).

Button: round buttons.

Silicone: to reduce sound impact between buttons and face plate.

Caractéristiques

Matière : laiton massif.

Fenêtre : 1 ouverture ronde + 2 ouvertures ronds pour BP (CD).

Bouton: boutons ronds.

Silicone : réduit l'impacte du son entre le bouton et la face avant.

POSITION

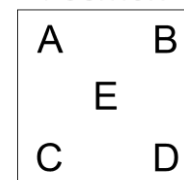

Ref.	Finish	Finition	Effect	Effet
PSI168LMH	Polished mirror brass	Laiton miroir	Shiny	Brillant
PSI168LBH	Brushed brass	Laiton brossé	Matt	Mat
PSI168LSH	Microbilled/satin brass	Laiton microbillé	Satin	Satin
PSI168VOH	Antique/old gold	Vieil or	Matt	Mat
PSI168BMH	Medium bronze	Bronze moyen	Matt	Mat
PSI168BRH	Dark bronze	Bronze noir	Shiny	Brillant
PSI168BZH	Grey bronze	Bronze gris	Matt	Mat
PSI168NMH	Polished mirror nickel	Nickel miroir	Shiny	Brillant
PSI168NBH	Brushed nickel	Nickel brossé	Matt	Mat
PSI168NSH	Microbilled/satin nickel	Nickel brossé	Matt	Mat
PSI168CHH	Polished mirror chrome	Chrome miroir	Shiny	Brillant
PSI168ROH	Brushed copper	Cuivre brossé	Matt	Mat
PSI168RAH	RAL code 9003	RAL codes 9003	Matt	Mat
PSI168ORH	24K gold	24K or	Shiny	Brillant
PSI168OMH	24K microbilled gold	microbillé 24K or	Satin	Satin

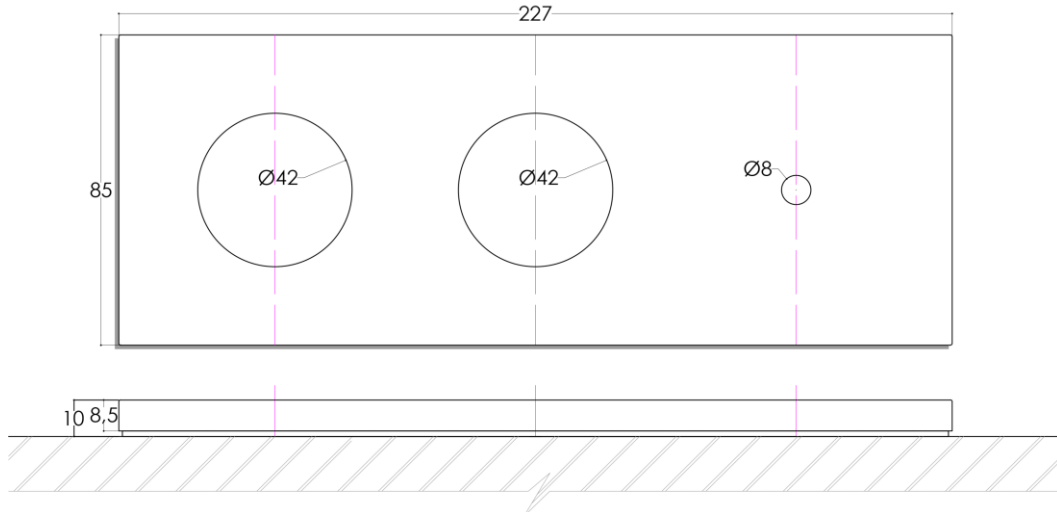

SIAM/NEVA

FRONT PLATE

FACE AVANT

Description

Material : full brass.
 Windows opening : 2 round holes + 1 round hole for PB (E).
 Button: round button.
 Silicone: to reduce sound impact between buttons and face plate.

POSITION

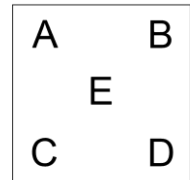

Caractéristiques

Matière : laiton massif.
 Fenêtre : 2 ouvertures rondes + 1 ouverture ronde pour BP (E).
 Bouton: bouton rond.
 Silicone : réduit l'impacte du son entre le bouton et la face avant.

Ref.	Finish	Finition	Effect	Effet
PSI169LMH	Polished mirror brass	Laiton miroir	Shiny	Brillant
PSI169LBH	Brushed brass	Laiton brossé	Matt	Mat
PSI169LSH	Microbilled/satin brass	Laiton microbillé	Satin	Satin
PSI169VOH	Antique/old gold	Vieil or	Matt	Mat
PSI169BMH	Medium bronze	Bronze moyen	Matt	Mat
PSI169BRH	Dark bronze	Bronze noir	Shiny	Brillant
PSI169BZH	Grey bronze	Bronze gris	Matt	Mat
PSI169NMH	Polished mirror nickel	Nickel miroir	Shiny	Brillant
PSI169NBH	Brushed nickel	Nickel brossé	Matt	Mat
PSI169NSH	Microbilled/satin nickel	Nickel brossé	Matt	Mat
PSI169CHH	Polished mirror chrome	Chrome miroir	Shiny	Brillant
PSI169ROH	Brushed copper	Cuivre brossé	Matt	Mat
PSI169RAH	RAL code 9003	RAL codes 9003	Matt	Mat
PSI169ORH	24K gold	24K or	Shiny	Brillant
PSI169OMH	24K microbilled gold	microbillé 24K or	Satin	Satin