

MANHATTAN

FRONT PLATE

FACE AVANT

Description

- Material : full brass.
- Windows opening : 1 square hole for PB (E).
- Button: square button.
- Silicone: to reduce sound impact between buttons and face plate.

Caractéristiques

- Matière : laiton massif.
- Fenêtre : 1 ouverture carré pour BP (E).
- Bouton: bouton carré.
- Silicone : réduit l'impacte du son entre le bouton et la face avant.

POSITION

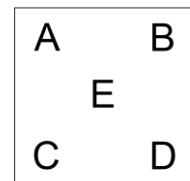

Ref.	Finish	Finition	Effect	Effet
PMA001LM	Polished mirror brass	Laiton miroir	Shiny	Brillant
PMA001LB	Brushed brass	Laiton brossé	Matt	Mat
PMA001LS	Microbilled/satin brass	Laiton microbillé	Satin	Satin
PMA001VO	Antique/old gold	Vieil or	Matt	Mat
PMA001BM	Medium bronze	Bronze moyen	Matt	Mat
PMA001BR	Dark bronze	Bronze noir	Shiny	Brillant
PMA001BZ	Grey bronze	Bronze gris	Matt	Mat
PMA001NM	Polished mirror nickel	Nickel miroir	Shiny	Brillant
PMA001NB	Brushed nickel	Nickel brossé	Matt	Mat
PMA001NS	Microbilled/satin nickel	Nickel brossé	Matt	Mat
PMA001CH	Polished mirror chrome	Chrome miroir	Shiny	Brillant
PMA001RO	Brushed copper	Cuivre brossé	Matt	Mat
PMA001RA	RAL code 9003	RAL codes 9003	Matt	Mat
PMA001OR	24K gold	24K or	Shiny	Brillant
PMA001OM	24K microbilled gold	microbillé 24K or	Satin	Satin

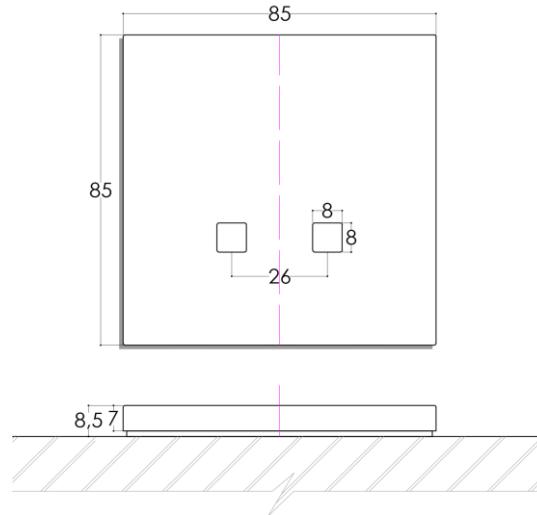

MANHATTAN

FRONT PLATE

FACE AVANT

Description

Material : full brass.
 Windows opening : 2 square holes for PB (CD).
 Button: square buttons.
 Silicone: to reduce sound impact between buttons and face plate.

POSITION

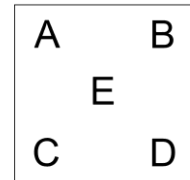

Caractéristiques

Matière : laiton massif.
 Fenêtre : 2 ouvertures carrés pour BP (CD).
 Bouton: boutons carrés.
 Silicone : réduit l'impacte du son entre le bouton et la face avant.

Ref.	Finish	Finition	Effect	Effet
PMA002LM	Polished mirror brass	Laiton miroir	Shiny	Brillant
PMA002LB	Brushed brass	Laiton brossé	Matt	Mat
PMA002LS	Microbilled/satin brass	Laiton microbillé	Satin	Satin
PMA002VO	Antique/old gold	Vieil or	Matt	Mat
PMA002BM	Medium bronze	Bronze moyen	Matt	Mat
PMA002BR	Dark bronze	Bronze noir	Shiny	Brillant
PMA002BZ	Grey bronze	Bronze gris	Matt	Mat
PMA002NM	Polished mirror nickel	Nickel miroir	Shiny	Brillant
PMA002NB	Brushed nickel	Nickel brossé	Matt	Mat
PMA002NS	Microbilled/satin nickel	Nickel brossé	Matt	Mat
PMA002CH	Polished mirror chrome	Chrome miroir	Shiny	Brillant
PMA002RO	Brushed copper	Cuivre brossé	Matt	Mat
PMA002RA	RAL code 9003	RAL codes 9003	Matt	Mat
PMA002OR	24K gold	24K or	Shiny	Brillant
PMA002OM	24K microbilled gold	microbillé 24K or	Satin	Satin

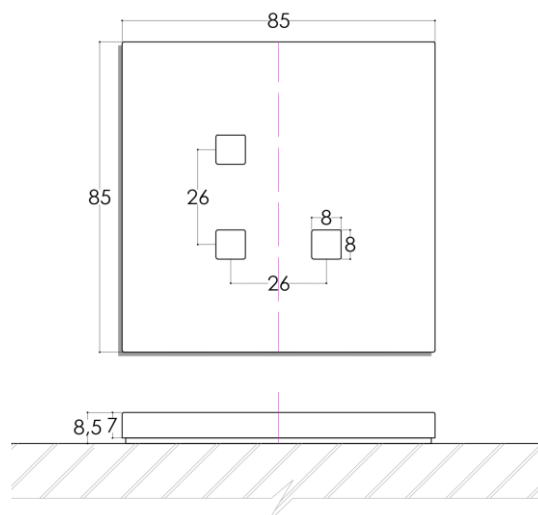

MANHATTAN

FRONT PLATE

FACE AVANT

Description

Material : full brass.

Windows opening : 3 square holes for PB (ACD).

Button: square buttons.

Silicone: to reduce sound impact between buttons and face plate.

Caractéristiques

Matière : laiton massif.

Fenêtre : 3 ouvertures carrés pour BP (ACD).

Bouton: boutons carrés.

Silicone : réduit l'impacte du son entre le bouton et la face avant.

POSITION

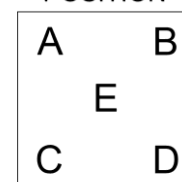

Ref.	Finish	Finition	Effect	Effet
PMA003LM	Polished mirror brass	Laiton miroir	Shiny	Brillant
PMA003LB	Brushed brass	Laiton brossé	Matt	Mat
PMA003LS	Microbilled/satin brass	Laiton microbillé	Satin	Satin
PMA003VO	Antique/old gold	Vieil or	Matt	Mat
PMA003BM	Medium bronze	Bronze moyen	Matt	Mat
PMA003BR	Dark bronze	Bronze noir	Shiny	Brillant
PMA003BZ	Grey bronze	Bronze gris	Matt	Mat
PMA003NM	Polished mirror nickel	Nickel miroir	Shiny	Brillant
PMA003NB	Brushed nickel	Nickel brossé	Matt	Mat
PMA003NS	Microbilled/satin nickel	Nickel brossé	Matt	Mat
PMA003CH	Polished mirror chrome	Chrome miroir	Shiny	Brillant
PMA003RO	Brushed copper	Cuivre brossé	Matt	Mat
PMA003RA	RAL code 9003	RAL codes 9003	Matt	Mat
PMA003OR	24K gold	24K or	Shiny	Brillant
PMA003OM	24K microbilled gold	microbillé 24K or	Satin	Satin

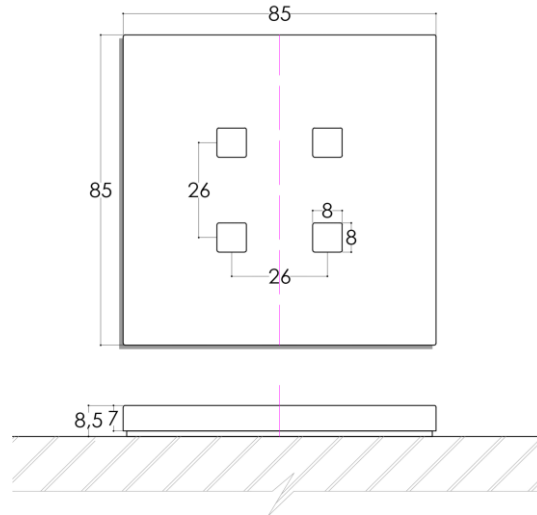

MANHATTAN

FRONT PLATE

FACE AVANT

Description

Material : full brass.

Windows opening : 4 square holes for PB (ABCD).

Button: square buttons.

Silicone: to reduce sound impact between buttons and face plate.

POSITION

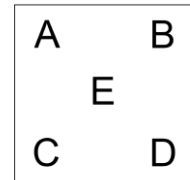

Caractéristiques

Matière : laiton massif.

Fenêtre : 4 ouvertures carrés pour BP (ABCD).

Bouton: boutons carrés.

Silicone : réduit l'impacte du son entre le bouton et la face avant.

Ref.	Finish	Finition	Effect	Effet
PMA004LM	Polished mirror brass	Laiton miroir	Shiny	Brillant
PMA004LB	Brushed brass	Laiton brossé	Matt	Mat
PMA004LS	Microbilled/satin brass	Laiton microbillé	Satin	Satin
PMA004VO	Antique/old gold	Vieil or	Matt	Mat
PMA004BM	Medium bronze	Bronze moyen	Matt	Mat
PMA004BR	Dark bronze	Bronze noir	Shiny	Brillant
PMA004BZ	Grey bronze	Bronze gris	Matt	Mat
PMA004NM	Polished mirror nickel	Nickel miroir	Shiny	Brillant
PMA004NB	Brushed nickel	Nickel brossé	Matt	Mat
PMA004NS	Microbilled/satin nickel	Nickel brossé	Matt	Mat
PMA004CH	Polished mirror chrome	Chrome miroir	Shiny	Brillant
PMA004RO	Brushed copper	Cuivre brossé	Matt	Mat
PMA004RA	RAL code 9003	RAL codes 9003	Matt	Mat
PMA004OR	24K gold	24K or	Shiny	Brillant
PMA004OM	24K microbilled gold	microbillé 24K or	Satin	Satin

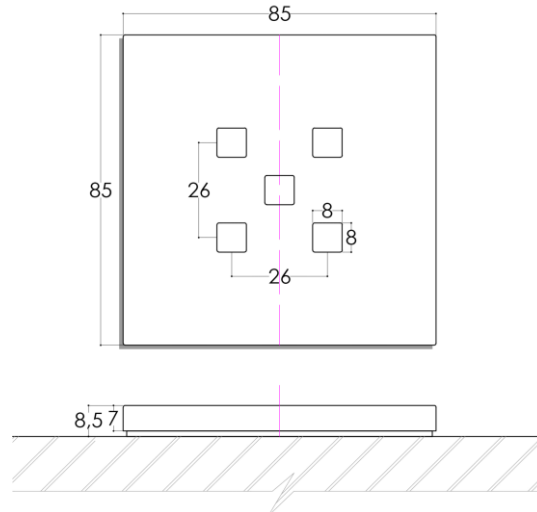

MANHATTAN

FRONT PLATE

FACE AVANT

Description

Material : full brass.

Windows opening : 5 square holes for PB (ABCDE).

Button: square buttons.

Silicone: to reduce sound impact between buttons and face plate.

POSITION

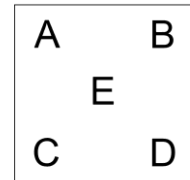

Caractéristiques

Matière : laiton massif.

Fenêtre : 5 ouvertures carrés pour BP (ABCDE).

Bouton: boutons carrés.

Silicone : réduit l'impacte du son entre le bouton et la face avant.

Ref.	Finish	Finition	Effect	Effet
PMA005LM	Polished mirror brass	Laiton miroir	Shiny	Brillant
PMA005LB	Brushed brass	Laiton brossé	Matt	Mat
PMA005LS	Microbilled/satin brass	Laiton microbillé	Satin	Satin
PMA005VO	Antique/old gold	Vieil or	Matt	Mat
PMA005BM	Medium bronze	Bronze moyen	Matt	Mat
PMA005BR	Dark bronze	Bronze noir	Shiny	Brillant
PMA005BZ	Grey bronze	Bronze gris	Matt	Mat
PMA005NM	Polished mirror nickel	Nickel miroir	Shiny	Brillant
PMA005NB	Brushed nickel	Nickel brossé	Matt	Mat
PMA005NS	Microbilled/satin nickel	Nickel brossé	Matt	Mat
PMA005CH	Polished mirror chrome	Chrome miroir	Shiny	Brillant
PMA005RO	Brushed copper	Cuivre brossé	Matt	Mat
PMA005RA	RAL code 9003	RAL codes 9003	Matt	Mat
PMA005OR	24K gold	24K or	Shiny	Brillant
PMA005OM	24K microbilled gold	microbillé 24K or	Satin	Satin

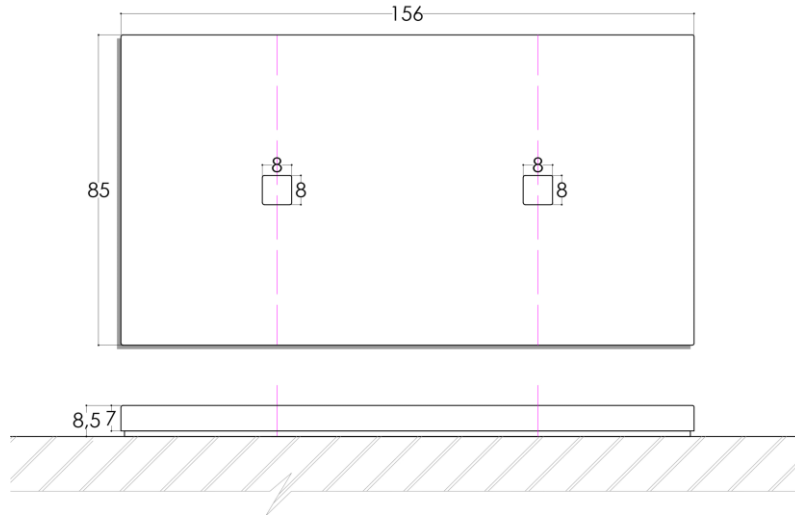

MANHATTAN

FRONT PLATE

FACE AVANT

Description

Material : full brass.

Windows opening : 2 square holes for PB (E, E).

Button: square buttons.

Silicone: to reduce sound impact between buttons and face plate.

POSITION

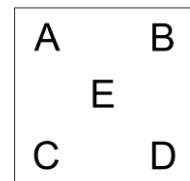

Caractéristiques

Matière : laiton massif.

Fenêtre : 2 ouvertures carrés pour BP (E, E).

Bouton: boutons carrés.

Silicone : réduit l'impacte du son entre le bouton et la face avant.

Ref.	Finish	Finition	Effect	Effet
PMA006LMH	Polished mirror brass	Laiton miroir	Shiny	Brillant
PMA006LBH	Brushed brass	Laiton brossé	Matt	Mat
PMA006LSH	Microbilled/satin brass	Laiton microbillé	Satin	Satin
PMA006VOH	Antique/old gold	Vieil or	Matt	Mat
PMA006BMH	Medium bronze	Bronze moyen	Matt	Mat
PMA006BRH	Dark bronze	Bronze noir	Shiny	Brillant
PMA006BZH	Grey bronze	Bronze gris	Matt	Mat
PMA006NMH	Polished mirror nickel	Nickel miroir	Shiny	Brillant
PMA006NBH	Brushed nickel	Nickel brossé	Matt	Mat
PMA006NSH	Microbilled/satin nickel	Nickel brossé	Matt	Mat
PMA006CHH	Polished mirror chrome	Chrome miroir	Shiny	Brillant
PMA006ROH	Brushed copper	Cuivre brossé	Matt	Mat
PMA006RAH	RAL code 9003	RAL codes 9003	Matt	Mat
PMA006ORH	24K gold	24K or	Shiny	Brillant
PMA006OMH	24K microbilled gold	microbillé 24K or	Satin	Satin

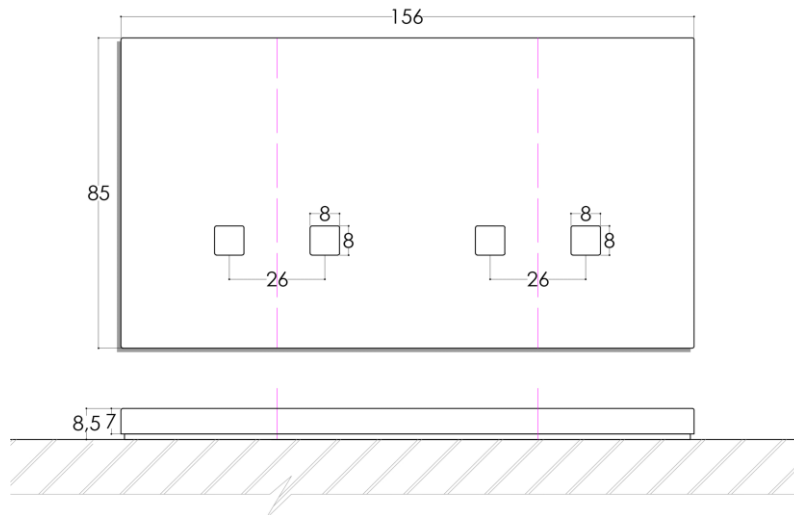

MANHATTAN

FRONT PLATE

FACE AVANT

Description

Material : full brass.

Windows opening : 4 square holes for PB (CD, CD).

Button: square buttons.

Silicone: to reduce sound impact between buttons and face plate.

POSITION

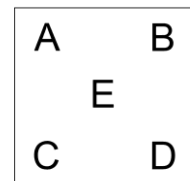

Caractéristiques

Matière : laiton massif.

Fenêtre : 4 ouvertures carrés pour BP (CD, CD).

Bouton: boutons carrés.

Silicone : réduit l'impacte du son entre le bouton et la face avant.

Ref.	Finish	Finition	Effect	Effet
PMA007LMH	Polished mirror brass	Laiton miroir	Shiny	Brillant
PMA007LBH	Brushed brass	Laiton brossé	Matt	Mat
PMA007LSH	Microbilled/satin brass	Laiton microbillé	Satin	Satin
PMA007VOH	Antique/old gold	Vieil or	Matt	Mat
PMA007BMH	Medium bronze	Bronze moyen	Matt	Mat
PMA007BRH	Dark bronze	Bronze noir	Shiny	Brillant
PMA007BZH	Grey bronze	Bronze gris	Matt	Mat
PMA007NMH	Polished mirror nickel	Nickel miroir	Shiny	Brillant
PMA007NBH	Brushed nickel	Nickel brossé	Matt	Mat
PMA007NSH	Microbilled/satin nickel	Nickel brossé	Matt	Mat
PMA007CHH	Polished mirror chrome	Chrome miroir	Shiny	Brillant
PMA007ROH	Brushed copper	Cuivre brossé	Matt	Mat
PMA007RAH	RAL code 9003	RAL codes 9003	Matt	Mat
PMA007ORH	24K gold	24K or	Shiny	Brillant
PMA007OMH	24K microbilled gold	microbillé 24K or	Satin	Satin

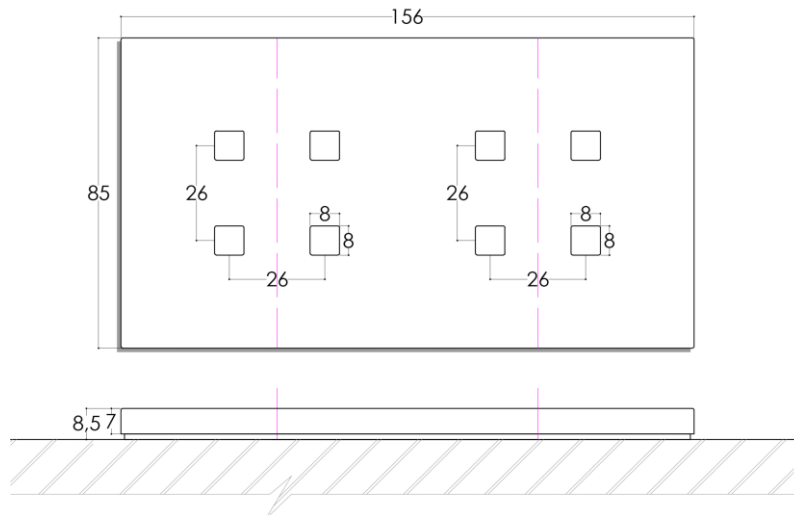

MANHATTAN

FRONT PLATE

FACE AVANT

Description

Material : full brass.

Windows opening : 8 square holes for PB (ABCD, ABCD).

Button: square buttons.

Silicone: to reduce sound impact between buttons and face plate.

POSITION

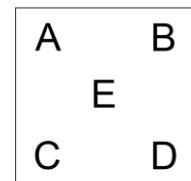

Caractéristiques

Matière : laiton massif.

Fenêtre : 8 ouvertures carrés pour BP (ABCD, ABCD).

Bouton: boutons carrés.

Silicone : réduit l'impacte du son entre le bouton et la face avant.

Ref.	Finish	Finition	Effect	Effet
PMA009LMH	Polished mirror brass	Laiton miroir	Shiny	Brillant
PMA009LBH	Brushed brass	Laiton brossé	Matt	Mat
PMA009LSH	Microbilled/satin brass	Laiton microbillé	Satin	Satin
PMA009VOH	Antique/old gold	Vieil or	Matt	Mat
PMA009BMH	Medium bronze	Bronze moyen	Matt	Mat
PMA009BRH	Dark bronze	Bronze noir	Shiny	Brillant
PMA009BZH	Grey bronze	Bronze gris	Matt	Mat
PMA009NMH	Polished mirror nickel	Nickel miroir	Shiny	Brillant
PMA009NBH	Brushed nickel	Nickel brossé	Matt	Mat
PMA009NSH	Microbilled/satin nickel	Nickel brossé	Matt	Mat
PMA009CHH	Polished mirror chrome	Chrome miroir	Shiny	Brillant
PMA009ROH	Brushed copper	Cuivre brossé	Matt	Mat
PMA009RAH	RAL code 9003	RAL codes 9003	Matt	Mat
PMA009ORH	24K gold	24K or	Shiny	Brillant
PMA009OMH	24K microbilled gold	microbillé 24K or	Satin	Satin

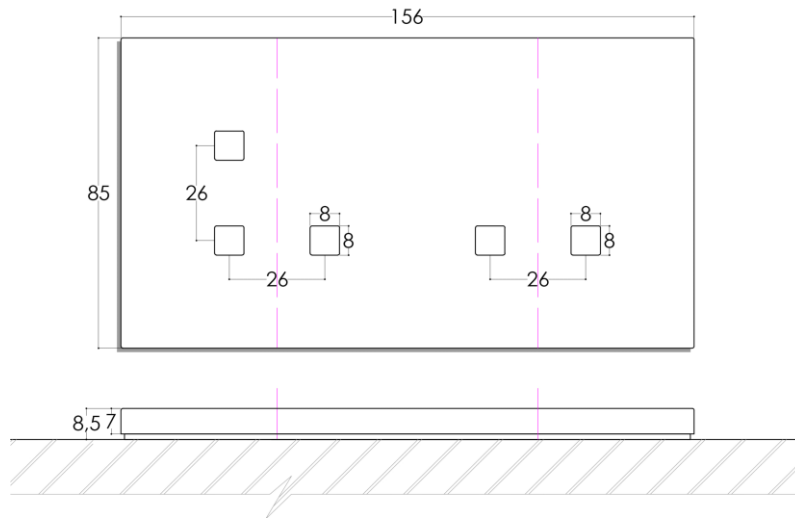

MANHATTAN

FRONT PLATE

FACE AVANT

Description

Material : full brass.

Windows opening : 5 square holes for PB (ACD, CD).

Button: squares buttons.

Silicone: to reduce sound impact between buttons and face plate.

Caractéristiques

Matière : laiton massif.

Fenêtre : 5 ouvertures carrés pour BP (ACD, CD).

Bouton: boutons carrés.

Silicone : réduit l'impacte du son entre le bouton et la face avant.

POSITION

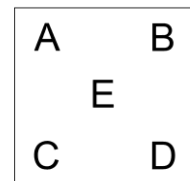

Ref.	Finish	Finition	Effect	Effet
PMA107LMH	Polished mirror brass	Laiton miroir	Shiny	Brillant
PMA107LBH	Brushed brass	Laiton brossé	Matt	Mat
PMA107LSH	Microbilled/satin brass	Laiton microbillé	Satin	Satin
PMA107VOH	Antique/old gold	Vieil or	Matt	Mat
PMA107BMH	Medium bronze	Bronze moyen	Matt	Mat
PMA107BRH	Dark bronze	Bronze noir	Shiny	Brillant
PMA107BZH	Grey bronze	Bronze gris	Matt	Mat
PMA107NMH	Polished mirror nickel	Nickel miroir	Shiny	Brillant
PMA107NBH	Brushed nickel	Nickel brossé	Matt	Mat
PMA107NSH	Microbilled/satin nickel	Nickel brossé	Matt	Mat
PMA107CHH	Polished mirror chrome	Chrome miroir	Shiny	Brillant
PMA107ROH	Brushed copper	Cuivre brossé	Matt	Mat
PMA107RAH	RAL code 9003	RAL codes 9003	Matt	Mat
PMA107ORH	24K gold	24K or	Shiny	Brillant
PMA107OMH	24K microbilled gold	microbillé 24K or	Satin	Satin

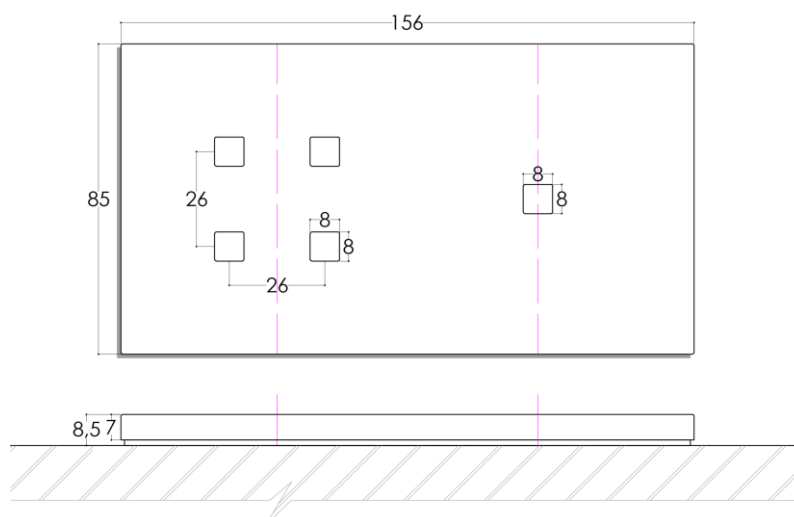

MANHATTAN

FRONT PLATE

FACE AVANT

Description

Material : full brass.

Windows opening : 5 square holes for PB (ABCD, E).

Button: squares buttons.

Silicone: to reduce sound impact between buttons and face plate.

POSITION

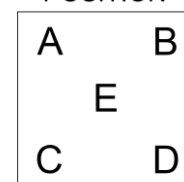

Caractéristiques

Matière : laiton massif.

Fenêtre : 5 ouvertures carrés pour BP (ABCD, E).

Bouton: boutons carrés.

Silicone : réduit l'impacte du son entre le bouton et la face avant.

Ref.	Finish	Finition	Effect	Effet
PMA121LMH	Polished mirror brass	Laiton miroir	Shiny	Brillant
PMA121LBH	Brushed brass	Laiton brossé	Matt	Mat
PMA121LSH	Microbilled/satin brass	Laiton microbillé	Satin	Satin
PMA121VOH	Antique/old gold	Vieil or	Matt	Mat
PMA121BMH	Medium bronze	Bronze moyen	Matt	Mat
PMA121BRH	Dark bronze	Bronze noir	Shiny	Brillant
PMA121BZH	Grey bronze	Bronze gris	Matt	Mat
PMA121NMH	Polished mirror nickel	Nickel miroir	Shiny	Brillant
PMA121NBH	Brushed nickel	Nickel brossé	Matt	Mat
PMA121NSH	Microbilled/satin nickel	Nickel brossé	Matt	Mat
PMA121CHH	Polished mirror chrome	Chrome miroir	Shiny	Brillant
PMA121ROH	Brushed copper	Cuivre brossé	Matt	Mat
PMA121RAH	RAL code 9003	RAL codes 9003	Matt	Mat
PMA121ORH	24K gold	24K or	Shiny	Brillant
PMA121OMH	24K microbilled gold	microbillé 24K or	Satin	Satin

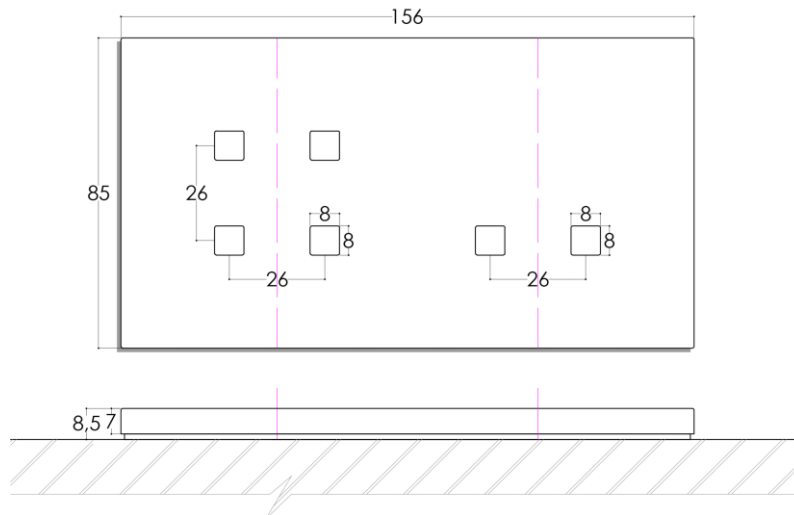

MANHATTAN

FRONT PLATE

FACE AVANT

Description

Material : full brass.

Windows opening : 6 square holes for PB (ABCD, CD).

Button: square buttons.

Silicone: to reduce sound impact between buttons and face plate.

POSITION

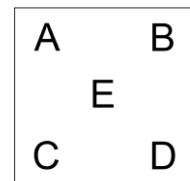

Caractéristiques

Matière : laiton massif.

Fenêtre : 6 ouvertures carrés pour BP (ABCD, CD).

Bouton: boutons carrés.

Silicone : réduit l'impacte du son entre le bouton et la face avant.

Ref.	Finish	Finition	Effect	Effet
PMA149LMH	Polished mirror brass	Laiton miroir	Shiny	Brillant
PMA149LBH	Brushed brass	Laiton brossé	Matt	Mat
PMA149LSH	Microbilled/satin brass	Laiton microbillé	Satin	Satin
PMA149VOH	Antique/old gold	Vieil or	Matt	Mat
PMA149BMH	Medium bronze	Bronze moyen	Matt	Mat
PMA149BRH	Dark bronze	Bronze noir	Shiny	Brillant
PMA149BZH	Grey bronze	Bronze gris	Matt	Mat
PMA149NMH	Polished mirror nickel	Nickel miroir	Shiny	Brillant
PMA149NBH	Brushed nickel	Nickel brossé	Matt	Mat
PMA149NSH	Microbilled/satin nickel	Nickel brossé	Matt	Mat
PMA149CHH	Polished mirror chrome	Chrome miroir	Shiny	Brillant
PMA149ROH	Brushed copper	Cuivre brossé	Matt	Mat
PMA149RAH	RAL code 9003	RAL codes 9003	Matt	Mat
PMA149ORH	24K gold	24K or	Shiny	Brillant
PMA149OMH	24K microbilled gold	microbillé 24K or	Satin	Satin