

# EDO/PARIS

## FRONT PLATE

### FACE AVANT

#### Description

Material : full brass.

Windows opening : 2 modules + 1 rectangle for PB (E).

Button: rectangular button.

Silicone: to reduce sound impact between buttons and face plate.

POSITION

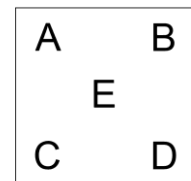

#### Caractéristiques

Matière : laiton massif.

Fenêtre : 2 modules + 1 ouverture rectangulaire pour BP (E).

Bouton: bouton rectangulaire.

Silicone : réduit l'impacte du son entre le bouton et la face avant.

Ref.	Finish	Finition	Effect	Effet
PPA031LMH	Polished mirror brass	Laiton miroir	Shiny	Brillant
PPA031LBH	Brushed brass	Laiton brossé	Matt	Mat
PPA031LSH	Microbilled/satin brass	Laiton microbillé	Satin	Satin
PPA031VOH	Antique/old gold	Vieil or	Matt	Mat
PPA031BMH	Medium bronze	Bronze moyen	Matt	Mat
PPA031BRH	Dark bronze	Bronze noir	Shiny	Brillant
PPA031BZH	Grey bronze	Bronze gris	Matt	Mat
PPA031NMH	Polished mirror nickel	Nickel miroir	Shiny	Brillant
PPA031NBH	Brushed nickel	Nickel brossé	Matt	Mat
PPA031NSH	Microbilled/satin nickel	Nickel brossé	Matt	Mat
PPA031CHH	Polished mirror chrome	Chrome miroir	Shiny	Brillant
PPA031ROH	Brushed copper	Cuivre brossé	Matt	Mat
PPA031RAH	RAL code 9003	RAL codes 9003	Matt	Mat
PPA031ORH	24K gold	24K or	Shiny	Brillant
PPA031OMH	24K microbilled gold	microbillé 24K or	Satin	Satin

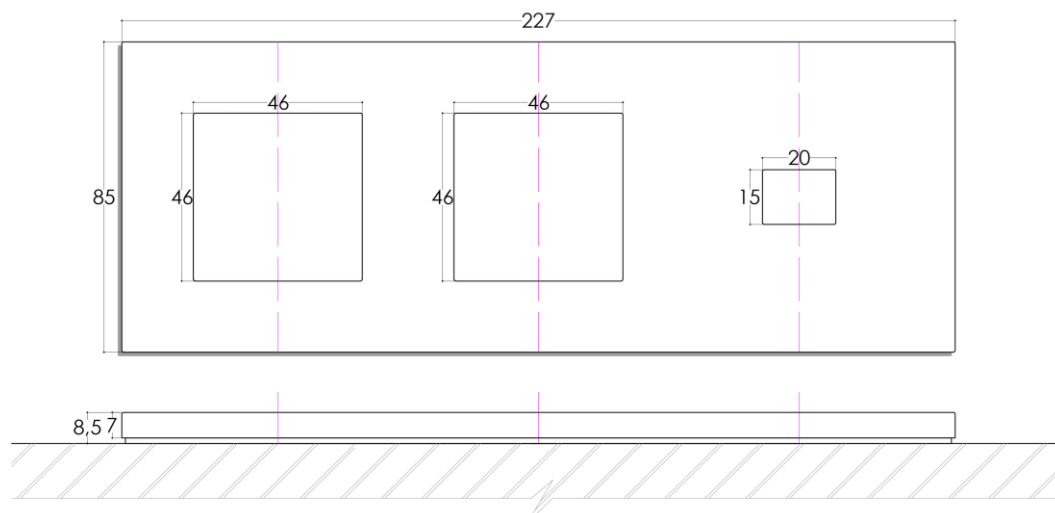

# EDO/PARIS

## FRONT PLATE

### FACE AVANT

#### Description

Material : full brass.

Windows opening : 2 modules + 2 modules + 1 rectangular hole for PB (E).

Button: rectangular button.

Silicone: to reduce sound impact between buttons and face plate.

POSITION

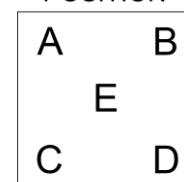

#### Caractéristiques

Matière : laiton massif.

Fenêtre : 2 modules + 2 modules + 1 ouverture rectangulaire pour BP (E).

Bouton: bouton rectangulaire.

Silicone : réduit l'impacte du son entre le bouton et la face avant.

Ref.	Finish	Finition	Effect	Effet
PPA069LMH	Polished mirror brass	Laiton miroir	Shiny	Brillant
PPA069LBH	Brushed brass	Laiton brossé	Matt	Mat
PPA069LSH	Microbilled/satin brass	Laiton microbillé	Satin	Satin
PPA069VOH	Antique/old gold	Vieil or	Matt	Mat
PPA069BMH	Medium bronze	Bronze moyen	Matt	Mat
PPA069BRH	Dark bronze	Bronze noir	Shiny	Brillant
PPA069BZH	Grey bronze	Bronze gris	Matt	Mat
PPA069NMH	Polished mirror nickel	Nickel miroir	Shiny	Brillant
PPA069NBH	Brushed nickel	Nickel brossé	Matt	Mat
PPA069NSH	Microbilled/satin nickel	Nickel brossé	Matt	Mat
PPA069CHH	Polished mirror chrome	Chrome miroir	Shiny	Brillant
PPA069ROH	Brushed copper	Cuivre brossé	Matt	Mat
PPA069RAH	RAL code 9003	RAL codes 9003	Matt	Mat
PPA069ORH	24K gold	24K or	Shiny	Brillant
PPA069OMH	24K microbilled gold	microbillé 24K or	Satin	Satin

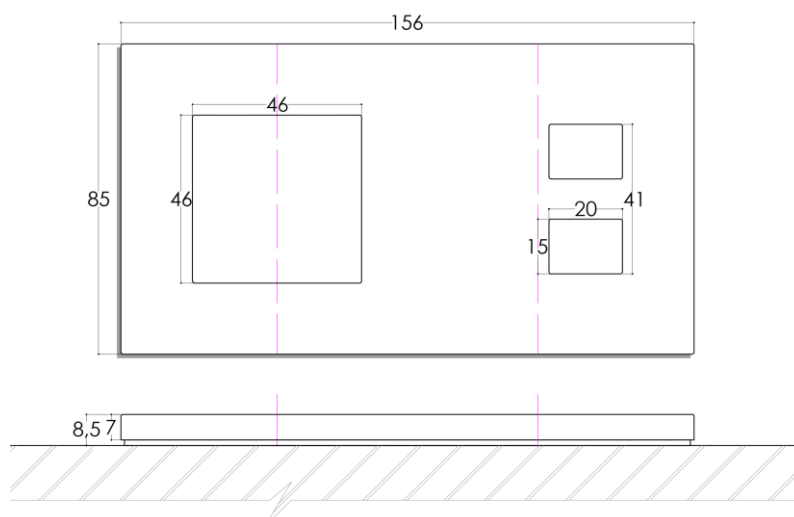

# EDO/PARIS

## FRONT PLATE

### FACE AVANT

#### Description

Material : full brass.

Windows opening : 2 modules + 2 rectangular holes for PB (BD).

Button: rectangular buttons.

Silicone: to reduce sound impact between buttons and face plate.

#### Caractéristiques

Matière : laiton massif.

Fenêtre : 2 modules + 2 ouvertures rectangulaires pour BP (BD).

Bouton: boutons rectangulaires.

Silicone : réduit l'impacte du son entre le bouton et la face avant.

POSITION

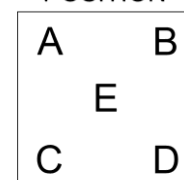

Ref.	Finish	Finition	Effect	Effet
PPA157LMH	Polished mirror brass	Laiton miroir	Shiny	Brillant
PPA157LBH	Brushed brass	Laiton brossé	Matt	Mat
PPA157LSH	Microbilled/satin brass	Laiton microbillé	Satin	Satin
PPA157VOH	Antique/old gold	Vieil or	Matt	Mat
PPA157BMH	Medium bronze	Bronze moyen	Matt	Mat
PPA157BRH	Dark bronze	Bronze noir	Shiny	Brillant
PPA157BZH	Grey bronze	Bronze gris	Matt	Mat
PPA157NMH	Polished mirror nickel	Nickel miroir	Shiny	Brillant
PPA157NBH	Brushed nickel	Nickel brossé	Matt	Mat
PPA157NSH	Microbilled/satin nickel	Nickel brossé	Matt	Mat
PPA157CHH	Polished mirror chrome	Chrome miroir	Shiny	Brillant
PPA157ROH	Brushed copper	Cuivre brossé	Matt	Mat
PPA157RAH	RAL code 9003	RAL codes 9003	Matt	Mat
PPA157ORH	24K gold	24K or	Shiny	Brillant
PPA157OMH	24K microbilled gold	microbillé 24K or	Satin	Satin

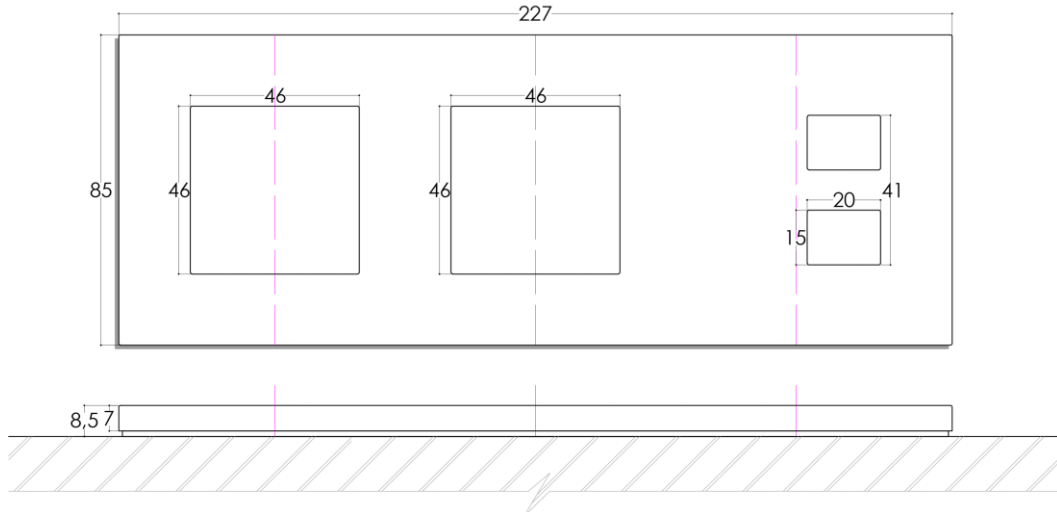

# EDO/PARIS

## FRONT PLATE

### FACE AVANT

#### Description

Material : full brass.

Windows opening : 2 modules + 2 modules + 2 rectangular holes for PB (BD).

Button: rectangular buttons.

Silicone: to reduce sound impact between buttons and face plate.

POSITION

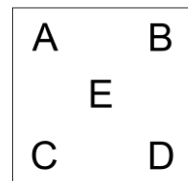

#### Caractéristiques

Matière : laiton massif.

Fenêtre : 2 modules + 2 modules + 2 ouvertures rectangulaires pour BP (BD).

Bouton: boutons rectangulaires.

Silicone : réduit l'impacte du son entre le bouton et la face avant.

Ref.	Finish	Finition	Effect	Effet
PPA164LMH	Polished mirror brass	Laiton miroir	Shiny	Brillant
PPA164LBH	Brushed brass	Laiton brossé	Matt	Mat
PPA164LSH	Microbilled/satin brass	Laiton microbillé	Satin	Satin
PPA164VOH	Antique/old gold	Vieil or	Matt	Mat
PPA164BMH	Medium bronze	Bronze moyen	Matt	Mat
PPA164BRH	Dark bronze	Bronze noir	Shiny	Brillant
PPA164BZH	Grey bronze	Bronze gris	Matt	Mat
PPA164NMH	Polished mirror nickel	Nickel miroir	Shiny	Brillant
PPA164NBH	Brushed nickel	Nickel brossé	Matt	Mat
PPA164NSH	Microbilled/satin nickel	Nickel brossé	Matt	Mat
PPA164CHH	Polished mirror chrome	Chrome miroir	Shiny	Brillant
PPA164ROH	Brushed copper	Cuivre brossé	Matt	Mat
PPA164RAH	RAL code 9003	RAL codes 9003	Matt	Mat
PPA164ORH	24K gold	24K or	Shiny	Brillant
PPA164OMH	24K microbilled gold	microbillé 24K or	Satin	Satin